

# BT7886

## MERSIVE SOLSTICE POD MOUNTING CRADLE

The BT7886 is a mounting cradle designed to securely mount a Mersive Solstice Pod onto a wall or desk, to a B-Tech accessory collar, or to the back of a display using any screen mount. The open design of the cradle helps to keep the Solstice Pod cool when in use and an integrated slot to add a Kensington lock (lock not included) helps prevent unauthorized removal of the device. B-Tech AV Mounts is an official Mounting Partner of Mersive Technologies.

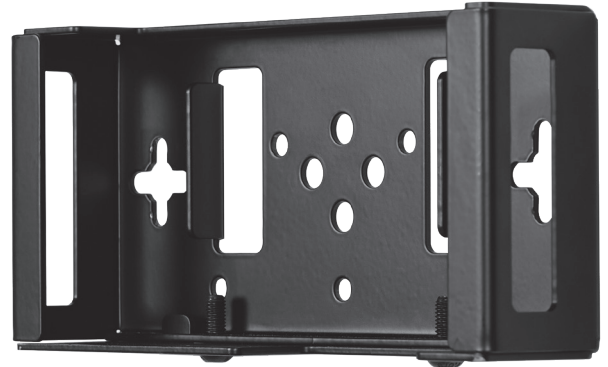

### SPECIFICATIONS

Designed for use with **Mersive Solstice Pod**  
 Dimensions **W: 7.4" H: 1.7" D: 3.8"**

### FEATURES

- Designed to securely hold a Mersive Solstice Pod
- 1 Can be fixed to poles, B-Tech collar or underneath a desk
- 2 Can also be mounted directly to a wall
- 3 Security screws to prevent unauthorized removal of Pod
- 4 Compatible with Kensington Slot Locks
- Security screws to prevent easy removal of Pod
- Supplied with an attachment plate for securing to mounting arms

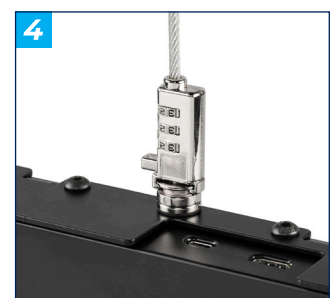

# BT7886

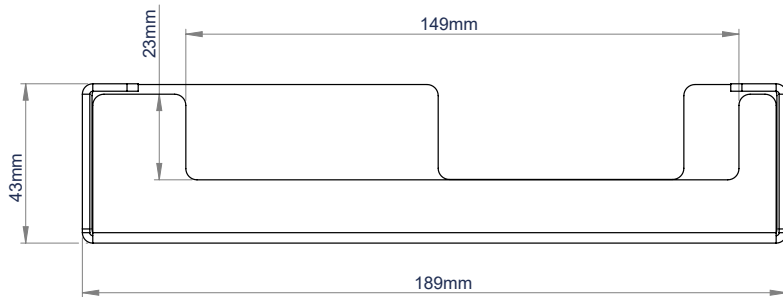

**TOP**

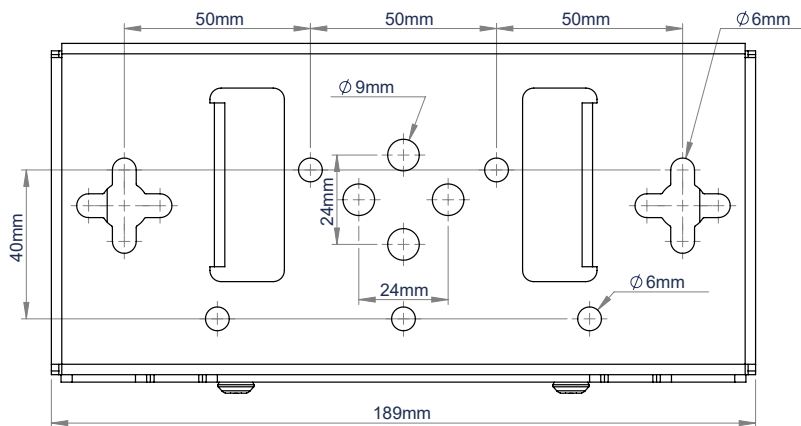

**BACK**

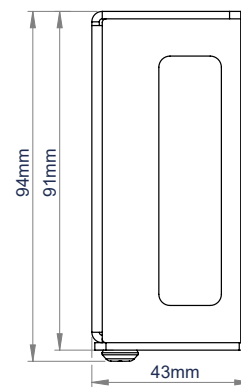

**SIDE**

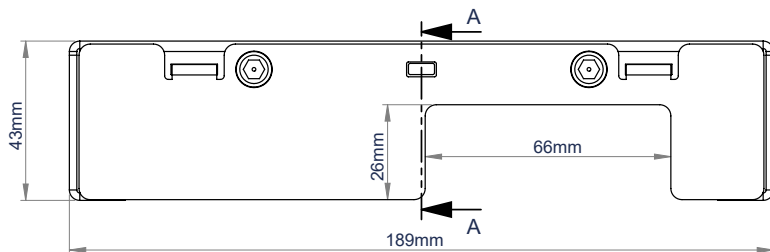

**BOTTOM**

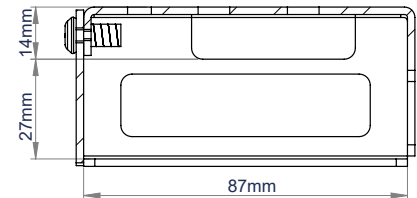

**SECTION A-A**

## ORDERING INFORMATION

COLOR	ORDER REF	BARCODE
Black	BT7886/B	5019318304118

## RELATED PRODUCTS

PRODUCT CODE	NAME	DESCRIPTION
BT7841	Ø2" 2-Piece Accessory Collar	Designed to attach a variety of different mounts and accessories onto B-Tech poles.
BT7850	Ø2" Poles	Available in Black, Chrome and white, designed for ceiling, floor or floor-to-ceiling
BT7883	Wall Mount with Slide-Out AV Tray	Designed to mount 32" to 72" screens and store AV media devices.
BT7885	Wall Mount with Pull-Down AV Tray	Designed to mount 32" to 72" screens and store AV media devices.

© 2015 B-Tech AV Mounts Co., Ltd. All rights reserved.  
 The information in this specification sheet reflects the current technical specifications at the time of printing.  
 We reserve the right to change the technical or physical specifications without prior notice. The B-Tech name and the B-Tech logo are registered trademarks of B-Tech AV Mounts Co., Ltd.  
 B-Tech is not responsible for any loss or damage caused by improper installation or mounting on unstable structures. Any reproduction or use without permission or registration of any part of this specification sheet is strictly prohibited. All rights reserved. permission is granted by B-Tech AV Mounts Co., Ltd. 2015.

SS-BT7886-140725