

SYSTEM **X**

Horizontal Mounting Rail

Length: 0.5m (19.7")

Parts List

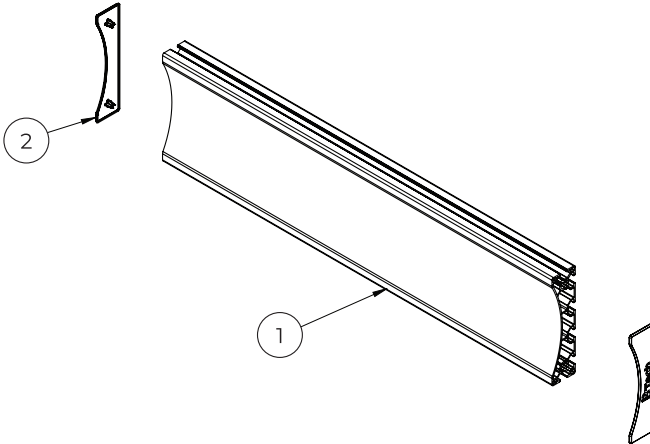

Item	Description	Qty
1	500mm Mounting Rail	1
2	End Cap	2

- Designed to be used in conjunction with B-Tech's System X range

Horizontal Mounting Rail

Length: 0.5m (19.7")

Dimensions

Do not attempt to install this product until all instructions and warnings have been read and properly understood. Please keep these instructions for future reference.

Please check carefully to make sure there are no missing or defective parts - defective parts must never be used.

B-Tech AV Mounts, its distributors and dealers are not liable or responsible for damage or injury caused by improper installation, improper use or failure to observe these safety instructions. In such cases, all guarantees will expire.

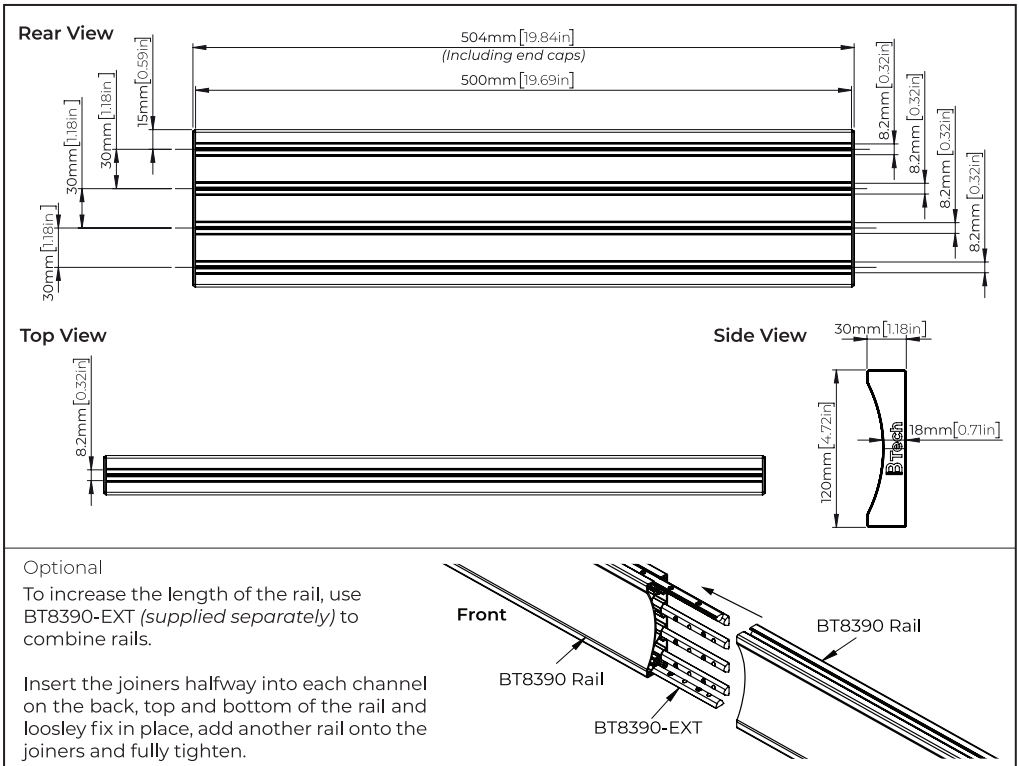

Contact: info@btechavmounts.com

©2024 B-Tech AV Mounts Corporation Ltd. All rights reserved.

B-Tech AV Mounts is a division of B-Tech AV Mounts Corporation Ltd. B-Tech AV Mounts and the B-Tech logo are registered trademarks. All B-Tech images and symbols are exclusive property of B-Tech AV Mounts Corporation Ltd. All other brands and product names are trademarks of their respective owners. Any reproduction, retransmission or republication of any part of this manual is strictly prohibited, unless prior written permission has been granted by B-Tech AV Mounts Corporation Ltd. Photographs are for illustrative purposes only. E&OE

AMA-BT8390-050-V3-0224-44 Made in the P.R.C.

