

BT9271

UNIVERSAL dvLED MOBILE STAND FOR ANY CONFIGURATION

Part of B-Tech's System Xpress range, BT9271 is a universal mobile solution suitable for any latching dvLED cabinet. Quick to quote and available at pace from stock, BT9271 is a simple to install dvLED mounting solution that is available to order in configurations that meet your exact needs.

System Xpress revolutionises dvLED mounting with its innovative, universal design for latching cabinets. Featuring B-Tech's **Patent Pending** universal **XpressConnect** clips instead of cabinet-specific interfaces, this system can be supplied rapidly from stock and quoted like any other stocked solution. The XpressConnect clips effortlessly hook-on and lock into the supplied mounting rails with a quick quarter turn of the twist-lock, enabling fast assembly of wall, floor, or ceiling mounted dvLED installations, making System Xpress the fastest dvLED mounting solution to go from order to install.



SPECIFICATIONS

Compatible Panels	All Latching Cabinets
Panel fixing method	Rear mounted using M6, M8 or M10 fixings
Height adjustment	+/-5mm
Depth adjustment	+/-5mm on wall plate (Additional +10mm at cabinet)
Colour	Black
For indoor use only	

FEATURES

- 1 Patent Pending **XpressConnect** technology
 - 2 Tool-less twist lock - cabinets 'hook-on' and lock in with a quarter turn
 - 3 Hang cabinets in pairs to speed up the install
 - 4 Includes non-marking 4" locking/braked castors for manoeuvrability
- Universally compatible with any latching cabinet
 - Row height spacer (available separately) to speed up the install
 - Open frame allows panel access for easy servicing and maintenance
 - Pre-configured 4x4, 5x5, 6x6, and 8x8 mounting kits also available
 - All mounting hardware included
 - Installation overview video available at www.btechavmounts.com/system-xpress-overview

Example Configurations:

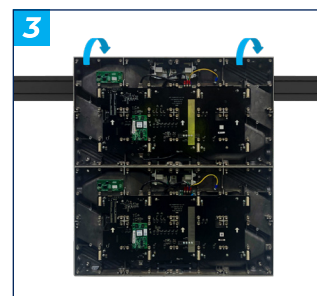
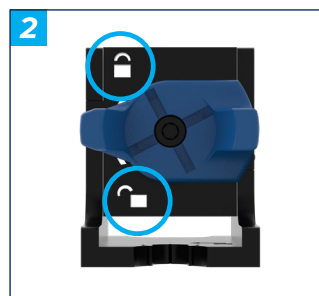
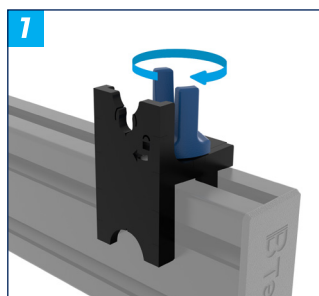
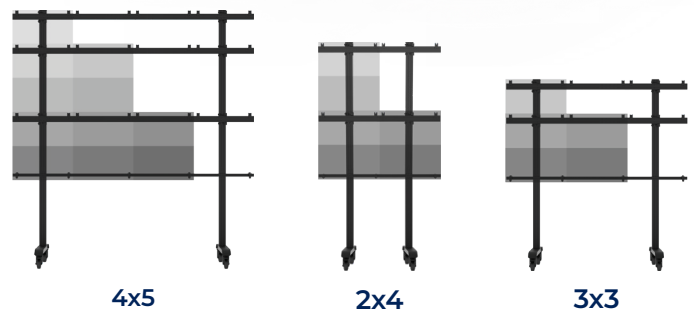

*Main product image indicative of a 5x3 configuration using 27" cabinets

BT9271

Bespoke Product Code Example:

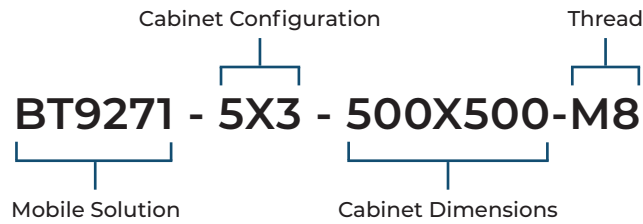

Pre-configured Kits:

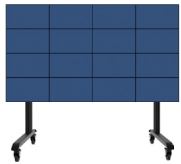
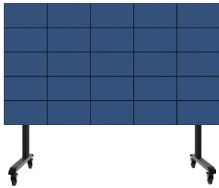
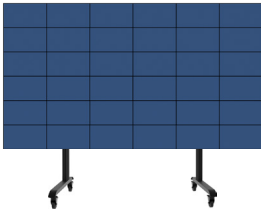
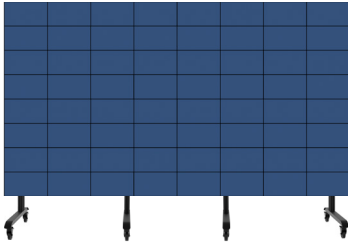
CONFIGURATIONS		PRODUCT CODE
	4x4	BTXPS27-M4X4
	5x5	BTXPS27-M5X5
	6x6	BTXPS27-M6X6
	8x8	BTXPS27-M8X8

RELATED PRODUCTS

PRODUCT CODE	NAME	DESCRIPTION
BTXPS27-M4X4	Universal 27" dvLED Mobile Stand	Designed to mount 27" LED cabinets in a 4x4 configuration
BTXPS27-M5X5	Universal 27" dvLED Mobile Stand	Designed to mount 27" LED cabinets in a 5x5 configuration
BTXPS27-M6X6	Universal 27" dvLED Mobile Stand	Designed to mount 27" LED cabinets in a 6x6 configuration
BTXPS27-M8X8	Universal 27" dvLED Mobile Stand	Designed to mount 27" LED cabinets in a 8x8 configuration

© 2022 B-Tech AV Mounts Corporation. All rights reserved.
 The information this specification sheet reflects the current technical specifications at the time of printing.
 We reserve the right to change the technical or physical specifications without prior notice. The B-Tech name and the B-Tech logo are registered trademarks of B-Tech AV Mounts Corporation Ltd.
 B-Tech is not responsible for loss or damage caused by improper installation or mounting on unstable structures. Any reproduction or use without our express permission is prohibited.
 Specification sheet is strictly for informational purposes and does not constitute a contract. B-Tech AV Mounts Corporation Ltd. (B-Tech)

SS-BT9271-2901.25