

BT93INFWP-M-5X5

MOBILE STAND FOR INFLED WP SERIES 5X5 DVLED VIDEOWALL

The BT93INFWP-M-5X5 is a mobile mounting solution designed specifically to mount INFLED WP-Series DVLED panels in a 5x5 videowall configuration. A high-end aesthetic, anodized aluminum finish and integrated cable management ensures a smart and stylish installation which is quick and simple to install.

SPECIFICATIONS

Panel fixing method	Rear mounted
Color (columns)	Black or Silver
Color (mounting frame)	Silver
For indoor use only	

FEATURES

- 1** Integrated cable management for a neat and tidy install
- 2** Includes non-marking 4" locking / braked castors
- Designed and configured specifically for INFLED WP-Series DVLED panels
- Keyhole mounting plates allow for easy rear fixed mounting
- Open frame allows panel access for servicing and maintenance
- Freestanding, bolt-down and ceiling mounted versions also available
- All mounting hardware included

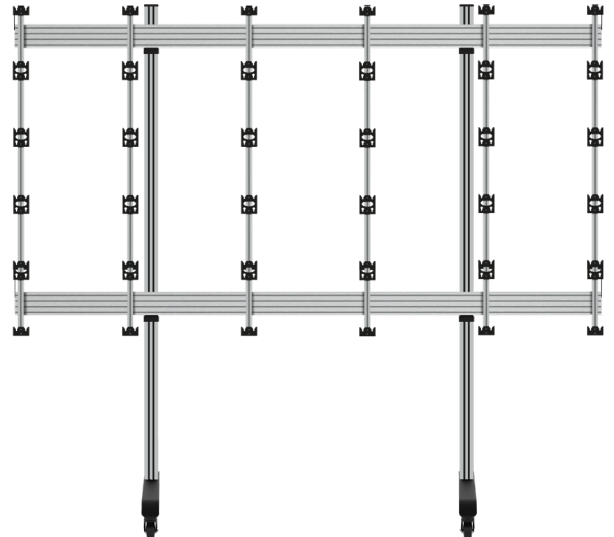

BT93INFWP-M-5X5

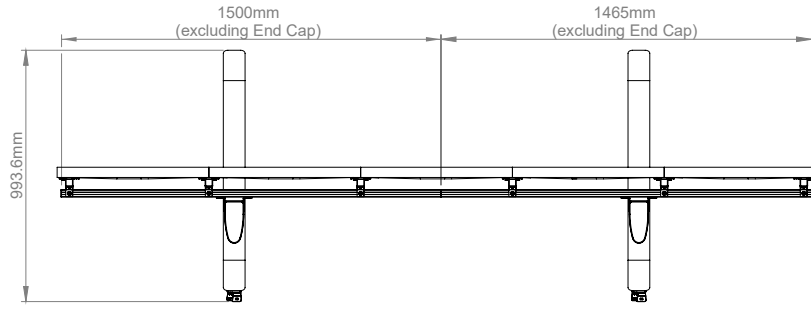

TOP VIEW

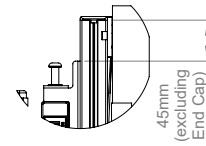

DETAIL A
SCALE 1 : 5

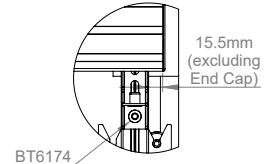

DETAIL B
SCALE 1 : 5

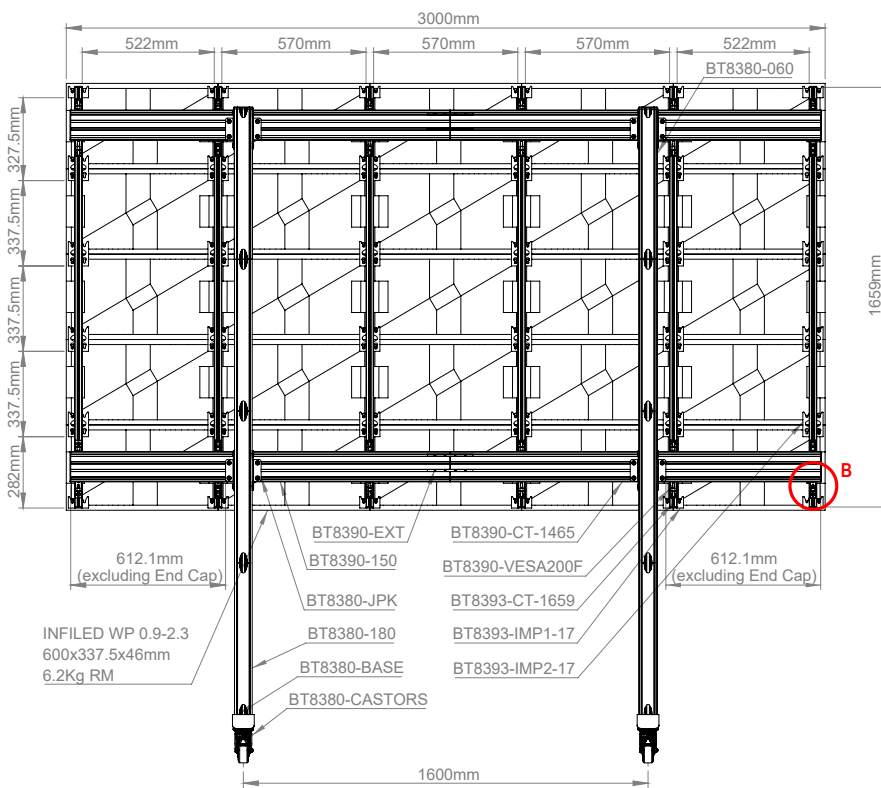
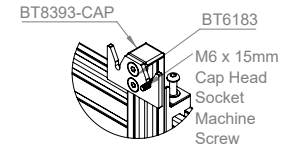
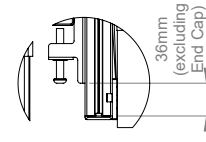

REAR VIEW

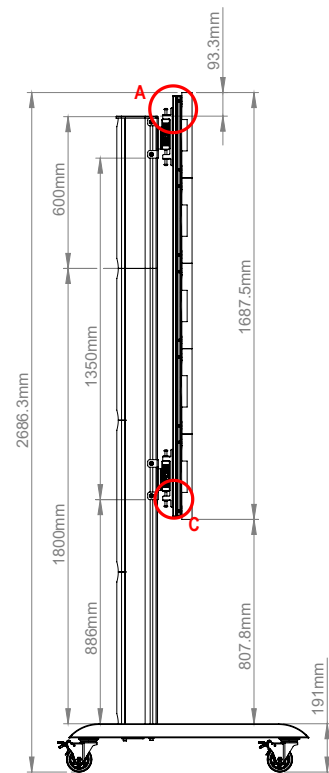

SIDE VIEW

ORDERING INFORMATION

COLOR	ORDER REF	BARCODE
Black Base w/ Silver Columns	BT93INFWP-M-5X5/BS	5019318303197
Black Base w/ Black Columns	BT93INFWP-M-5X5/BB	5019318303203

RELATED PRODUCTS

PRODUCT CODE	NAME	DESCRIPTION
BT93INFWP-M-4X4	Mobile Cart	For INFILED WP Series 4x4 DVLED Videowall
BT93INFWP-S-5X5	Floor Stand	For INFILED WP Series 5x5 DVLED Videowall
BT93INFWP-B-5X5	Bolt Down Stand	For INFILED WP Series 5x5 DVLED Videowall
BT93INFWP-C-5X5	Ceiling Mount	For INFILED WP Series 5x5 DVLED Videowall

© 2015 B Tech AV Mounts Co. Limited. All rights reserved. The information in this specification sheet reflects the current technical specifications at the time of printing. We reserve the right to change the technical or physical specifications without prior notice. This is not a contract. B Tech AV Mounts Co. Ltd. is not responsible for any loss or damage caused by improper installation or mounting on unsuitable structures. Any reproduction or use without permission is strictly prohibited. For more information, please contact us at sales@btechavmounts.com or call 020 8000 1800.