

BT93INFWP-S-5X5

FLOOR STAND FOR INFLED WP SERIES 5X5 DVLED VIDEOWALL

The BT93INFWP-S-5X5 is a freestanding mounting solution designed specifically to mount INFLED WP-Series DVLED panels in a 5x5 videowall configuration. A high-end aesthetic, anodised aluminium finish and integrated cable management ensures a smart and stylish installation which is quick and simple to install.

SPECIFICATIONS

Panel fixing method	Rear mounted
Colour (columns)	Black or Silver
Colour (mounting frame)	Silver
For indoor use only	

FEATURES

- 1** Integrated cable management for a neat and tidy install
- 2** Adjustable levelling feet to accommodate uneven floor surfaces
- Designed and configured specifically for INFLED WP-Series DVLED panels
- Keyhole mounting plates allow for easy rear fixed mounting
- Open frame allows panel access for servicing and maintenance
- Mobile, bolt-down and ceiling mounted versions also available
- All mounting hardware included

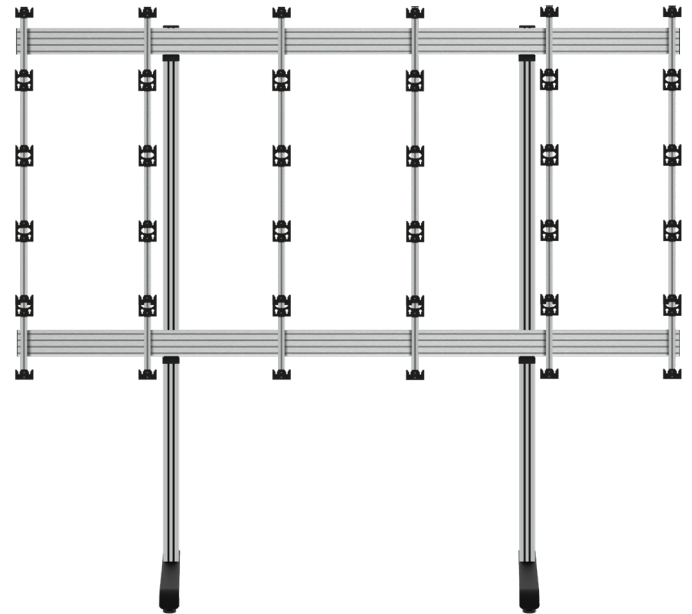

BT93INFWP-S-5X5

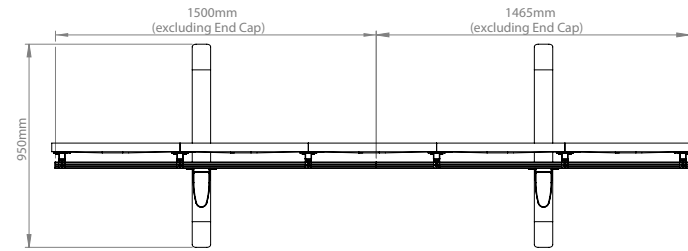

TOP VIEW

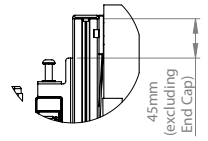

DETAIL A

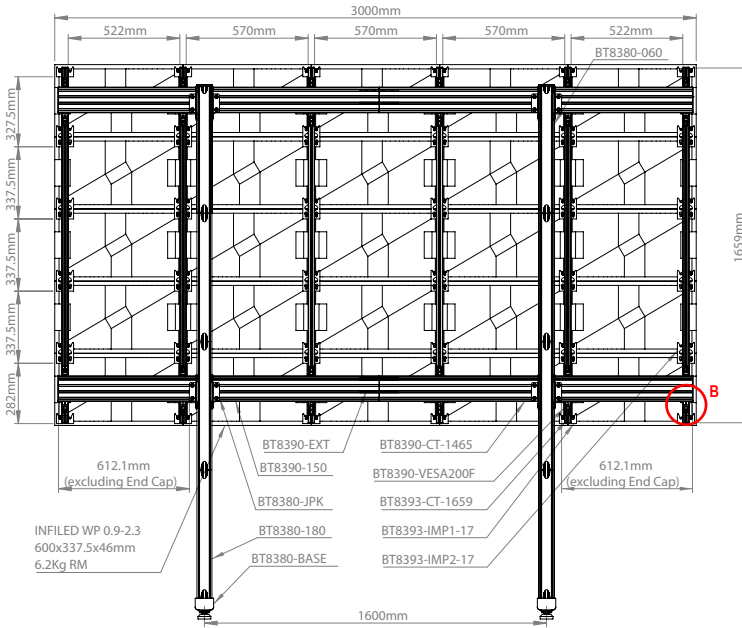

REAR VIEW

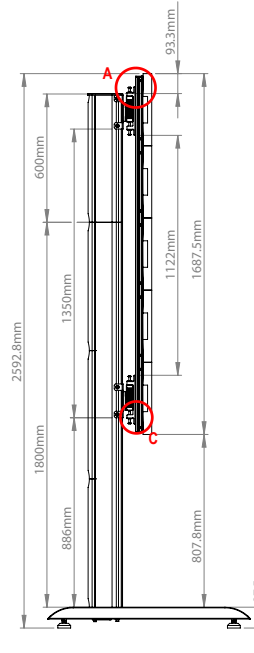

SIDE VIEW

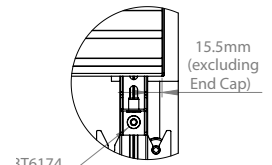

DETAIL B

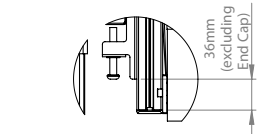

DETAIL C

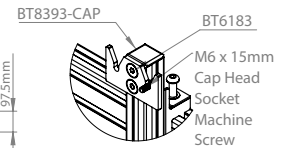

DETAIL D

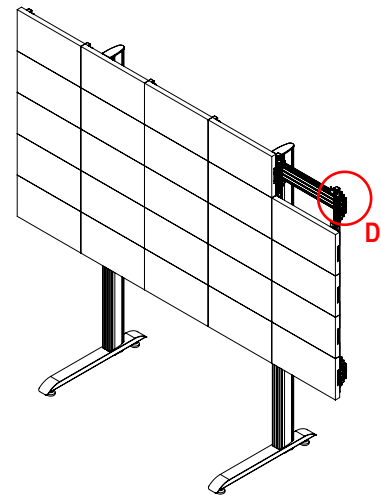

ISOMETRIC VIEW

ORDERING INFORMATION

COLOUR	ORDER REF	EAN
Black Base w/ Silver Columns	BT93INFWP-S-5X5/BS	5019318303159
Black Base w/ Black Columns	BT93INFWP-S-5X5/BB	5019318303166

RELATED PRODUCTS

PRODUCT CODE	NAME	DESCRIPTION
BT93INFWP-S-4X4	Floor Stand	For INFiLED WP Series 4x4 DVLED Videowall
BT93INFWP-M-5X5	Mobile Trolley	For INFiLED WP Series 5x5 DVLED Videowall
BT93INFWP-B-5X5	Bolt Down Stand	For INFiLED WP Series 5x5 DVLED Videowall
BT93INFWP-C-5X5	Ceiling Mount	For INFiLED WP Series 5x5 DVLED Videowall

© 2018 B.Tech. AV Mounts Co. Ltd. All rights reserved.
 The information in this specification sheet reflects the current technical specifications at the time of printing.
 We reserve the right to change the technical or physical specifications without prior notice. This is both a warning and the B.Tech. AV Mounts Co. Ltd.
 logo is a registered trademark of B.Tech. AV Mounts Co. Ltd. All other trademarks are the property of their respective owners.
 B.Tech. AV Mounts Co. Ltd. is not responsible for any damage or loss of data caused by improper installation or use of the product. Any reproduction or use of this
 specification sheet is strictly prohibited unless prior written permission is granted by B.Tech. AV Mounts Co. Ltd. 02061.

SS-V2-BT93INFWP-S-5X5-130924