



Mode-AL Mounting Guide:

Ceiling / Wall / Floor

Create a custom Mode-AL display stand in 3 simple steps

Complete off-the-shelf kits are available, but for greater flexibility and convenience components can be supplied individually and used to create custom installations to suit any application.

Step 1 Choose Floor / Ceiling Fixing

Ceiling Mounts

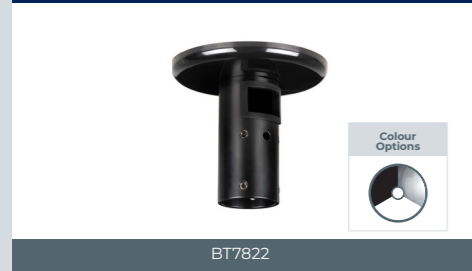

BT7822

Floor-To-Wall Mount



BT8385-CTW

Floor Bases

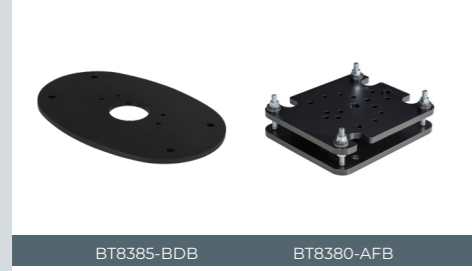

BT8385-BDB

BT8380-AFB



BT8385-SXB

BT8385-SCB



BT8385-TXB

BT8385-TCB

Braked Castors



Use with BT8385-SXB or BT8385-TXB

BTW075-4

Step 2 Choose Column / Pole Length

Ø50mm Poles

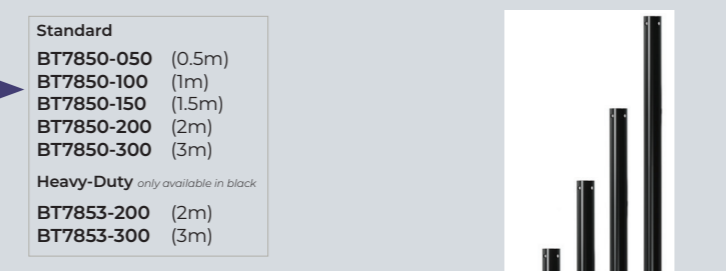

- Standard**
- BT7850-050 (0.5m)
 - BT7850-100 (1m)
 - BT7850-150 (1.5m)
 - BT7850-200 (2m)
 - BT7850-300 (3m)
- Heavy-Duty** *only available in black*
- BT7853-200 (2m)
 - BT7853-300 (3m)

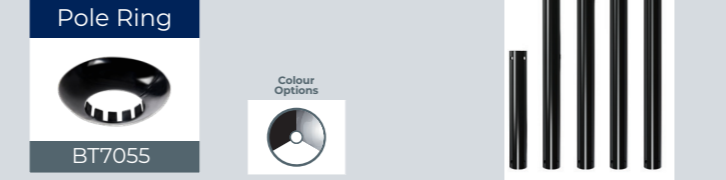

Pole Ring

BT7055

Floor To Ceiling Mounting Kit



*Includes additional column extension kit for combining vertical columns if required.

BT8385-FTC

Columns



BT8385-130 (1.3m)

BT8385-190 (1.9m)

Step 3 Choose Mounting Rail, Interface Arms and any additional accessories

Screen Interface Arms



Mounting Rails

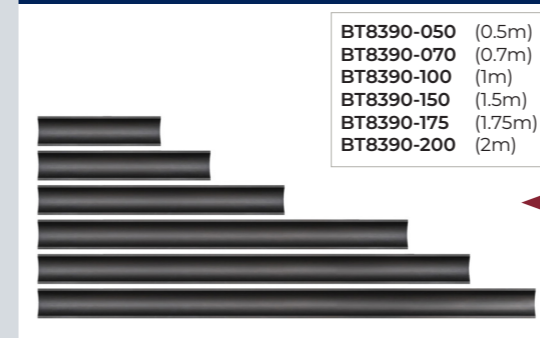

- BT8390-050 (0.5m)
- BT8390-070 (0.7m)
- BT8390-100 (1m)
- BT8390-150 (1.5m)
- BT8390-175 (1.75m)
- BT8390-200 (2m)

Joining Kit

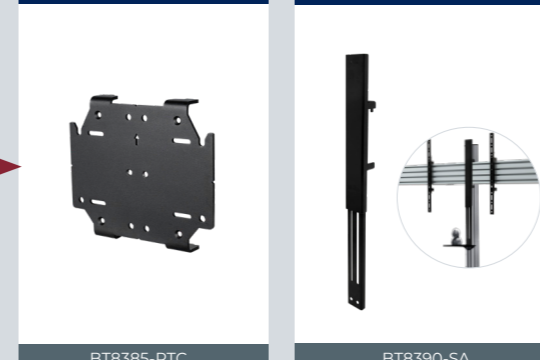

BT8385-RTC

Camera Mount

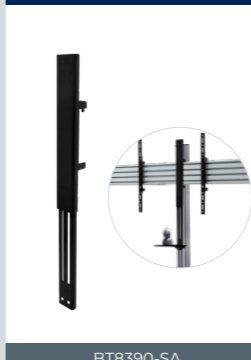

BT8390-SA

Accessories



BT7863

BT7033

BT7032

Off-The-Shelf Complete Mode-AL Solutions

Single Screen Floor-To-Ceiling



BT8702

Single Screen Floor-To-Wall



BT8700

BT8701

BT8707

Twin Screen Bolt-Down



BT8703

BT8704

BT8708

BT8711

Freestanding

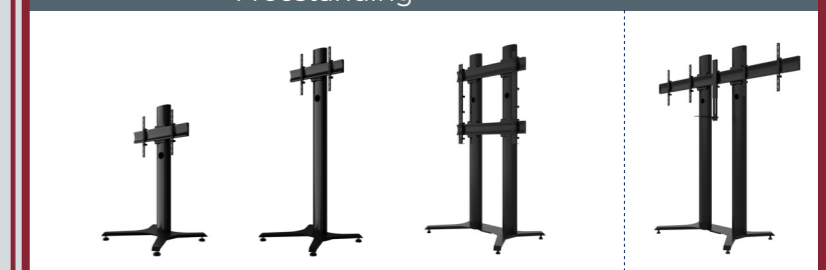

BT8705

BT8706

BT8709

BT8712

Media Storage / Video Bar Mounts / UC Equipment

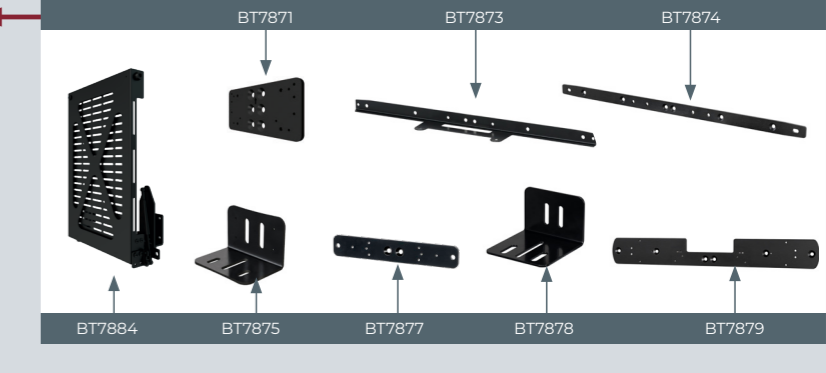

BT7871

BT7873

BT7874

BT7884

BT7875

BT7877

BT7878

BT7879

View the full range now...

